

decora smart™

LEVITON



Dimmer with Wi-Fi® Technology

Cat. No. DW6HD

Universal Incandescent, LED, CFL Dimmer

Rated: 120 VAC, 60 Hz
600W Incandescent
300W LED/CFL

INSTALLATION INSTRUCTIONS

Control lights from anywhere using the My Leviton App



© 2017 Leviton Mfg. Co., Inc.

DI-000-DW6HD-02A

COPYRIGHT AND TRADEMARK INFORMATION

Decora is a registered trademark and Decora Smart and My Leviton App are trademarks of Leviton Manufacturing Co., Inc.

Use herein of third party trademarks, service marks, trade names, brand names and/or product names are for informational purposes only, are/may be the trademarks of their respective owners; such use is not meant to imply affiliation, sponsorship, or endorsement. No part of this document may be reproduced, transmitted or transcribed without the express written permission of Leviton Manufacturing Co., Inc.

TECHNICAL SUPPORT

For additional information contact Leviton's Technical Support at: 1-800-824-3005 or visit Leviton's website at www.leviton.com

FOR CANADA ONLY

For warranty information and/or product returns, residents of Canada should contact Leviton in writing at **Leviton Manufacturing of Canada Ltd to the attention of the Quality Assurance Department, 165 Hymus Blvd, Pointe-Claire (Quebec), Canada H9R 1E9** or by telephone at 1-800-405-5320.

LIMITED 5 YEAR WARRANTY AND EXCLUSIONS

Leviton warrants to the original consumer purchaser and not for the benefit of anyone else that this product at the time of its sale by Leviton is free of defects in materials and workmanship under normal and proper use for five years from the purchase date. Leviton's only obligation is to correct such defects by repair or replacement, at its option. For details visit www.leviton.com or call 1-800-824-3005. This warranty excludes and there is disclaimed liability for labor for removal of this product or reinstallation. This warranty is void if this product is installed improperly or in an improper environment, overloaded, misused, opened, abused, or altered in any manner, or is not used under normal operating conditions or not in accordance with any labels or instructions. **There are no other or implied warranties of any kind, including merchantability and fitness for a particular purpose,** but if any implied warranty is required by the applicable jurisdiction, the duration of any such implied warranty, including merchantability and fitness for a particular purpose, is limited to five years. **Leviton is not liable for incidental, indirect, special, or consequential damages, including without limitation, damage to, or loss of use of, any equipment, lost sales or profits or delay or failure to perform this warranty obligation.** The remedies provided herein are the exclusive remedies under this warranty, whether based on contract, tort or otherwise.

© 2017 Leviton Mfg. Co., Inc.

DI-000-DW6HD-02A

Step 5 Testing your Dimmer prior to mounting in wall box:

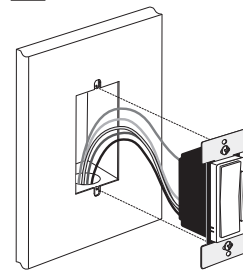

- Position all wires to provide room in outlet wall box for dimmer.
- Ensure that the word "TOP" is facing up on dimmer strap.
- Partially screw in mounting screws in wall box mounting holes.

NOTE: Dress wires with a bend as shown in diagram in order to relieve stress when mounting dimmer.

- Restore power at circuit breaker or fuse.
- Press pad until locator light is OFF. Lights should turn ON. If lights do not turn ON, press the TOP half of the DIM/BRIGHT Bar until the lights brighten.

If lights still do not turn ON, refer to the TROUBLESHOOTING section.

Step 6 Dimmer Mounting: TURN OFF POWER AT CIRCUIT BREAKER OR FUSE.

Installation may now be completed by tightening mounting screws into wall box. Attach wall plate.

Step 7 Restore Power: Restore power at circuit breaker or fuse. Installation is complete.

OPERATION

NOTE: At default the locator light will illuminate when the load is in the OFF position to facilitate access in the dark.

NOTE: If using the dimmer in a 3-way application, the lights will turn ON at brightness set on dimmer's DIM/BRIGHT bar. The lighting can be controlled from either the dimmer, the remote location or a My Leviton App.

Rocker (Default settings)

Turn ON from OFF position: Tap TOP of Rocker: Lights turn ON to preset level.

Turn OFF from ON position: Tap BOTTOM of Rocker. Lights turn OFF.

DIM/BRIGHT Bar

BRIGHTEN: Tap the TOP half of the DIM/BRIGHT Bar – Lights will jump to the next brightness setting. Hold the TOP half of the DIM/BRIGHT Bar – Lights will brighten.

DIM: Tap the BOTTOM half of the DIM/BRIGHT Bar – Lights will jump to the next dim setting. Hold the BOTTOM half of the DIM/BRIGHT Bar – Lights will dim.

NOTE: When lights are OFF you can change the light level that the lights will turn ON to using the DIM/BRIGHT Bar. If there is a power outage, when the power is restored, the lights will return to the last setting before the power interruption.

AIR GAP

On the dimmer only, engage the air-gap switch by gently pulling out from the bottom of the DIM/BRIGHT Bar until the bottom of the bar lifts completely out of the frame and a click is heard (refer to Figure). LED's will turn OFF. This will stop power to the fixture to replace the bulb. After servicing is complete, press the DIM/BRIGHT Bar back into place for normal operation.

Cleaning: Clean with a damp cloth. DO NOT use chemical cleaners.

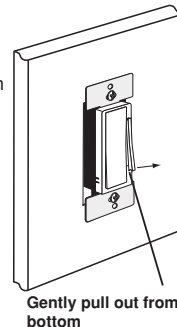
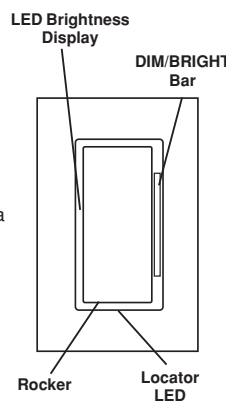
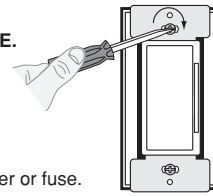
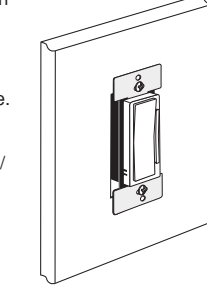

GETTING STARTED

Leviton Wi-Fi® devices use the my.Leviton.com cloud service to provide connectivity from your mobile device when you are home or away. If this is your first Leviton Wi-Fi® device, use the My Leviton app or browse to my.Leviton.com and setup a free account.

DECORA SMART™ Wi-Fi® SETUP

Leviton Wi-Fi® devices are compatible with the My Leviton App and my.Leviton.com cloud service. The app is used to pair your device with your Wi-Fi® network, customize your device configuration and provide communication via my.Leviton.com. To control the Leviton Wi-Fi® device it will need to be added to a Wi-Fi® network with Internet access:

- Download the My Leviton App.
- Ensure the Leviton accessory is properly wired and power is applied.
- Upon initial power-up the Locator LED will flash green to show the accessory is ready to be configured.
- If the Locator LED is no longer flashing green when you are ready to add the accessory, press and hold the paddle for 7 seconds until the Locator LED turns amber and release.
- Within the app follow the on screen instructions or press + to add the device to the Wi-Fi® network and my.Leviton.com account.
- Leviton Wi-Fi® devices support Wi-Fi® 802.11 a/b/g/n networks @ 2.4GHz and 5GHz with WPA or WPA2 security.

CHANGING NETWORK CONFIGURATION

In situations where a wireless access point or password is changed but the configuration of the dimmer needs to remain, use the following changing network procedure:

- Press and hold the paddle for 7 seconds until the Locator LED turns amber and release.
- The locator LED will flash green.
- Open the My Leviton App.
- Navigate to the device.
- On the device page select Details.
- Within the Details section choose Reconfigure Wireless and follow the app instructions.

FACTORY DEFAULT

In situations where a dimmer needs to be returned to factory default follow these steps:

- Hold the top of the paddle for a total of 14 seconds.
 - After the first 7 seconds the LED turns amber.
 - Continue to hold the top of the paddle until the Locator LED quickly flashes red/amber.
- Release the top of the paddle and the dimmer will reset.

DECORA SMART™ FEATURES

Decora Smart™ products contain unique features which can be configured via the My Leviton App.

Load Type Setup: Leviton Decora Smart™ dimmers are compatible with different types of loads. Choosing the correct load type will increase compatibility and provide proper operation.

- Incandescent Loads (Default)
- LED Loads
- CFL Loads

Locator LED Setup:

Leviton Decora Smart™ dimmers have a locator LED on the bottom of the paddle. The LED can be used to locate the dimmer in the dark, indicate the current load status, or can be turned OFF at all times.

- **Status Mode:** Uses the LED to reflect the current state of the light. If the light is currently ON, the LED is ON, if the light is currently OFF, the LED is OFF.
- **Locator Mode (default):** Uses the LED to help find the dimmer in a dark room. If the light is currently OFF, the LED is ON, if the light is currently ON, the LED is OFF.
- **LED OFF:** Places the LED in a permanently OFF state.

LED Level Indicator Timeout

The LED indicators on the side of the dimmer can be programmed to be ON, OFF, or timeout after a predefined period of time.

- Level Indicators OFF
- Level Indicator Timeout (seconds)
- Levels Indicators Always ON

Fade Times

Adjusting the ON or OFF time will affect the speed that the lighting load will transition. Both ON and OFF times can be configured separately.

Light Levels

The dimmer can be set to allow a minimum or maximum lighting level. When using LED bulbs it is recommended to adjust the minimum light level to the lowest level possible when the load is illuminated without flicker.

Preset Light Level

The preset light level feature addresses how the dimmer behaves when turned ON. Default is memory dim, a feature that returns the dimmer to the last dim level. Alternatively, preset dim can be set which will place the dimmer to a level predefined by the app regardless of the last known state. In both modes the dim/bright bar can be used to select a dim level before turning the load ON.

TROUBLESHOOTING

- **Lights Flickering**
 - Lamp has a bad connection.
 - Wires not secured firmly with wire connectors of dimmer or terminal screws of remote.
 - If using in a dimmable fluorescent application see **Load Type Setup prior to testing the dimmer.**
- **Light does not turn ON and Locator LED does not turn ON**
 - Circuit breaker or fuse has tripped.
 - Lamp is burned out.
 - Neutral not wired to dimmer (White wire).
 - Confirm that the dimmer is being supplied from a 120V AC, 60 Hz source ONLY.
- **Intermittent dimmer operation**
 - Confirm that the Load being controlled does not exceed the 600W dimmer limit.
- **Remote does not operate lights**
 - Ensure that total wire length does not exceed 300 ft.
 - Ensure wiring is correct.

FCC COMPLIANCE STATEMENT

This device complies with Part 15 of the FCC Rules. Operation is subject to following two conditions: (1) this device may not cause harmful interference, and (2) this device must accept any interference received, including interference that may cause undesired operation of the device.

This equipment has been tested and found to comply with the limits for a Class B Digital Device, pursuant to Part 15 of the FCC Rules. These limits are designed to provide reasonable protection against harmful interference in a residential installation. This equipment generates, uses, and can radiate radio frequency energy and, if not installed and used in accordance with the instructions, may cause harmful interference to radio communications. However, there is no guarantee that interference will not occur in a particular installation. If this equipment does cause harmful interference to radio or television reception, which can be determined by turning the equipment OFF and ON, the user is encouraged to try to correct the interference by one or more of the following measures:

- Reorient or relocate the receiving Antenna.
- Increase the separation between the equipment and the receiver.
- Connect the equipment into an outlet on a circuit different from that to which the receiver is connected.
- Consult the dealer or an experienced radio/tv technician for help.

FCC CAUTION

Any changes or modifications not expressly approved by Leviton Manufacturing Co., Inc., could void the user's authority to operate the equipment.

IC COMPLIANCE STATEMENT

This device complies with Industry Canada licence-exempt RSS standard(s). Operation is subject to the following two conditions: (1) this device may not cause interference, and (2) this device must accept any interference, including interference that may cause undesired operation of the device.

WEB VERSION

WARNINGS AND CAUTIONS

- **TO AVOID FIRE, SHOCK, OR DEATH; TURN OFF POWER** at circuit breaker or fuse and test that power is off before wiring!
- **TO AVOID FIRE, PERSONAL INJURY OR PROPERTY DAMAGE, DO NOT** install to control a receptacle, a motor, or a transformer operated appliance.
- To be installed and/or used in accordance with electrical codes and regulations.
- If you are unsure about any part of these instructions, consult an electrician.
- Use with incandescent, LED, CFL or 120V halogen fixtures only. Use a Leviton electronic low voltage dimmer to control electronic (solid state) low voltage transformers.
- The Decora Smart™ DW6HD dimmer is not compatible with standard 3-way or 4-way switches. It must be used with up to 4 Decora® Digital DD00R-DL remotes for multi-location dimming.
- Maximum wire length from dimmer to all installed remotes cannot exceed 300 ft.
- Save this instruction sheet. It contains important technical data along with testing and troubleshooting information which will be useful after installation is complete.

WARNINGS AND CAUTIONS

- Dimmer may feel warm to the touch during normal operation.
- Recommended minimum wall box depth is 2-3/4".
- Use this dimmer **with copper or copper clad wire only**.
- Use with compatible dimmable LED, CFL bulbs, incandescent or 120V halogen fixtures only. For a list of compatible LED and CFL bulbs refer to www.leviton.com.
- DO NOT mix bulb types when multiple bulbs are used with one dimmer. All bulbs shall be either LED; CFL or incandescent. Using the same make/model of each bulb will enhance dimmer performance.
- Leviton Wi-Fi® enabled devices rely on Wi-Fi® communication. Increasing the number of Wi-Fi® devices can affect Wi-Fi® performance. Consult the network's wireless access point specifications to determine the maximum number of supported Wi-Fi® devices. For installations with a large number of Leviton Wi-Fi® devices, a high performance wireless access point capable of supporting a large number of devices may be required.

INTRODUCTION

Leviton's Decora Smart™ Wi-Fi® devices are designed to streamline home control using the cloud, apps and connectivity with key industry partners. The my.Leviton.com cloud service provides an easy, secure way to control devices from an iOS or Android app, as well as any web browser. After installing your Decora Smart™ device, configure it from the My Leviton App with just a few simple steps. You can create custom scenes to control your home settings. Through the my.Leviton.com site you can integrate with exciting and constantly expanding group of third party partners to create a complete home automation system. Decora Smart™ devices are ideal for living rooms, bedrooms, kitchens, dining rooms, home offices, outdoor lighting or anywhere full control of lighting is desired.

WARNING: TO AVOID FIRE, PERSONAL INJURY OR DEATH DO NOT USE the remote for the control of high power heating appliances such as portable heaters. There can be some unexpected consequences if not used with care. For example, an empty coffee pot can be remotely turned on. If that should happen, your coffee pot could be damaged from overheating. If an electric heater is turned on by remote control while clothing is draped over it, a fire could result. This dimmer will not control lighting that is used with electronic low-voltage and high frequency power supply transformers, nor high pressure discharge lamps (HID lighting). This includes mercury-vapor, sodium vapor and metal halide lamps.

RATINGS

Incandescent - 600W - 120VAC, 60Hz
LED/CFL - 300W - 120VAC, 60Hz

FEATURES

- The Decora Smart™ Wi-Fi® Dimmer provides app control and scheduling without the need of an automation hub
- Compatible with my.Leviton.com cloud service for device control from a mobile device inside or away from the home
- Soft fade ON/OFF
- ON/OFF LED and Brightness level LED
- Over The Air (OTA) firmware updates via the My Leviton App
- Single pole or three way compatible
- Ease of installation

REQUIRED

- Wi-Fi® Network
- Free My Leviton App

TOOLS NEEDED TO INSTALL YOUR DIMMER

Slotted/Phillips Screwdriver Electrical Tape Pliers
Pencil Cutters Ruler

Changing the color of your Dimmer:

Your dimmer may include color options. To change color of the face proceed as follows:

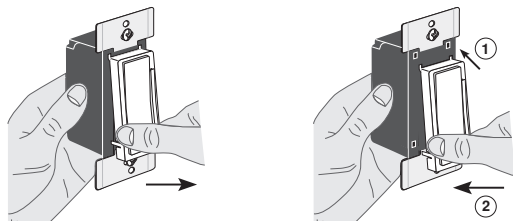

Push in sides at bottom tabs and pull outward to release

Insert top tabs and press in bottom tabs to attach

INSTALLING DIMMER BY ITSELF OR WITH MULTI-GANG

If installing the dimmer in a single gang application, proceed with the **INSTALLING YOUR DIMMER** section. If installing Dimmer in a multi-gang application, proceed as follows:

MULTI-GANG APPLICATION

In multi-dimmer installations, the reduction of the dimmer's capacity may be required. Refer to the chart for maximum load per dimmer. **NOTE:** No derating is required for LED or CFL bulb applications.

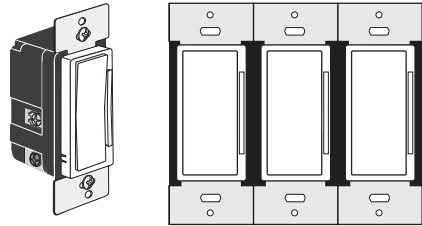

MAXIMUM LOAD PER DIMMER FOR MULTI-GANG			
Load	Single	Two Gang	More than 2 Gang
Incand	600W	500W	500W

INSTALLING YOUR DIMMER

NOTE: Use check boxes when Steps are completed.

Step 1 **WARNING: TO AVOID FIRE SHOCK OR DEATH; TURN OFF POWER** at circuit breaker or fuse and test that power is off before wiring!

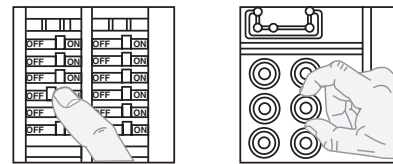

Step 2 **Identifying your wiring application (most common):**

NOTE: If the wiring in your wall box does not resemble any of these configurations, consult an electrician.

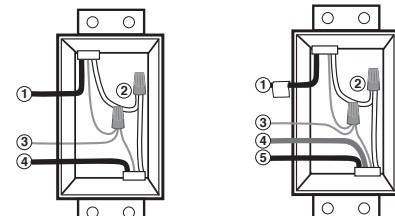

Single Pole

1. Line (Hot)
2. Neutral
3. Ground
4. Load

3-Way

1. Line or Load (see important instruction)
2. Neutral
3. Ground
4. First Traveler – note color
5. Second Traveler – note color

IMPORTANT: For 3-Way applications, note that one of the screw terminals from the old switch being removed will usually be a different color (Black) or labeled Common. Tag that wire with electrical tape and identify as the Common (Line or Load) in both the dimmer wall box and remote wall box.

Step 3

Preparing and connecting wires: This dimmer can be wired using side wire terminal screws or through backwire openings. Choose appropriate wire stripping specifications accordingly.

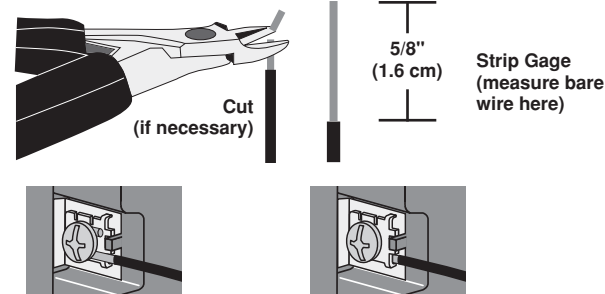

Side Wire Connection
Side wire terminals accept #14-12 AWG solid copper wire only.

Back Wire Connection
Back wire openings accept #14-12 AWG solid copper wire only.

- Make sure that the ends of the wires from the wall box are straight (cut if necessary).
- Remove insulation from each wire in the wall box as shown.
- **For Single-Pole Application, go to Step 4a.**
- **For 3-Way Matching Remote (with LEDs) Application, go to Step 4b.**

For non-standard wiring applications, refer to Wire Connector and Conductor Size Chart

WIRE CONNECTOR / # OF COND. COMBINATION CHART

1 - #12 w/ 1 to 3 #14, #16 or #18
2 - #12 w/ 1 or 2 #16 or #18
1 - #14 w/ 1 to 4 #16 or #18
2 - #14 w/ 1 to 3 #16 or #18

Step 4a

Single Pole Wiring Application:

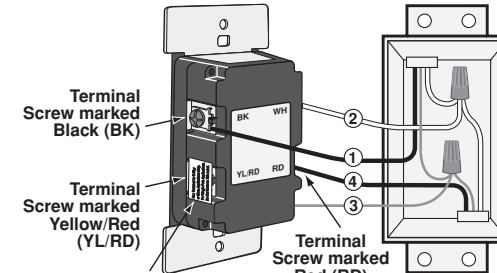

Terminal Label: Use terminal for 3-way or more applications only. For single-pole applications, DO NOT remove label.

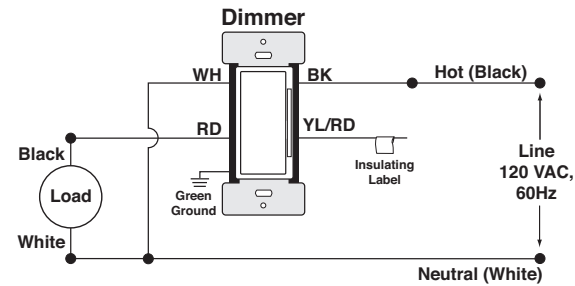

WIRING DIMMER:

Connect wires per **WIRING DIAGRAM** as follows:

NOTE: The DW6HD dimmer requires a neutral connection.

- Green or bare copper wire in wall box to Green dimmer terminal screw.
- Line Hot wall box wire to Black dimmer terminal screw.
- Load wall box wire to Red dimmer terminal screw.
- Neutral wall box wire to White dimmer terminal screw.
- Yellow/Red dimmer terminal screw should have Red insulation label affixed.

NOTE: If insulating label is not affixed to Yellow/Red dimmer terminal screw, use electrical tape to cover.

- **Proceed to step 5.**

Step 4b

3-Way Wiring with DD00R Matching Remote (with LED) Application:

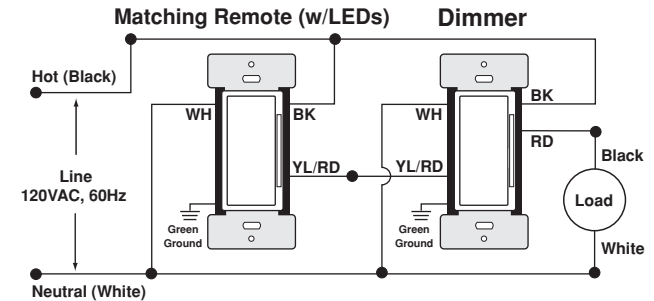
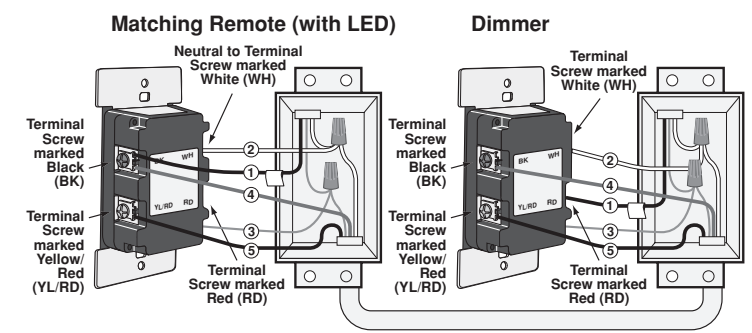

WIRING DIMMER

(wall box with load connection):

Connect wires per **WIRING DIAGRAM** as follows:

- **NOTE:** The DW6HD dimmer must be installed in a wall box that has a Load connection. The dimmer also requires a neutral connection.
- Green or bare copper wire in wall box to Green terminal screw.
- Load wall box wire identified (tagged) when removing old switch to dimmer terminal screw marked "RD".
- First Traveler Line Hot to dimmer terminal screw marked "BK".
- Remove Red insulating label from terminal screw marked "YL/RD".
- Second Traveler wall box wire (note color as above) to dimmer terminal screw marked "YL/RD". This traveler from the dimmer must go to the terminal screw on the remote marked "YL/RD".
- Neutral wall box wire to White dimmer terminal screw.

WIRING MATCHING REMOTE

(wall box with Line Hot connection):

Connect wires per **WIRING DIAGRAM** as follows:

- **NOTE:** The matching remote must be installed in a wall box with a Line Hot connection and a Neutral connection. A Neutral wire to the matching remote needs to be added as shown. If you are unsure about any part of these instructions, consult an electrician.
- **NOTE:** Maximum wire length from dimmer to all installed remotes cannot exceed 300 ft (90m).
- Green or bare copper wire in wall box to Green terminal screw.
- Line Hot (common) wall box wire identified (tagged) when removing old switch and First Traveler to remote terminal screw marked "BK".
- Second Traveler wall box wire from dimmer to remote terminal screw marked "YL/RD" (note wire color). This traveler from the remote must go to the terminal screw on the dimmer marked "YL/RD".
- Line Neutral wall box to remote terminal screw marked "WH".

NOTE: To synchronize LEDs between a Decora® digital remote and the Decora® DW6HD dimmer, a dim up or dim down command must be pressed on the remote.

- **Proceed to Step 5.**

WEB VERSION